

1		2		3		4		5		6		7		8						
A:	0.6	0.7								标记 MARK.		ECN编号/变更内容 ECN NO./DEFINITION		日期 DATE		修改 REVISE		核准 APPROVE		
B:	A+0.4																			

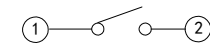

CIRCUIT DIAGRAM

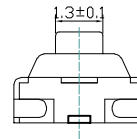
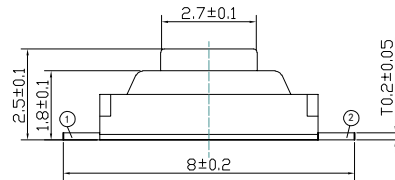
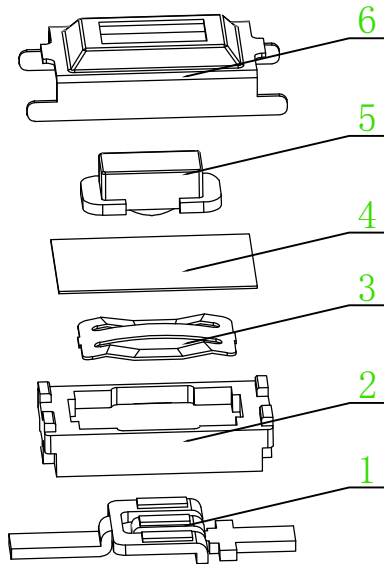
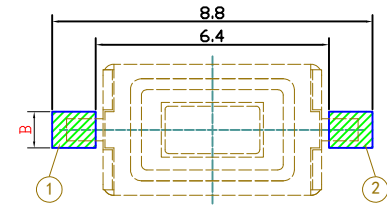
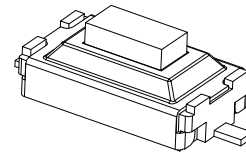
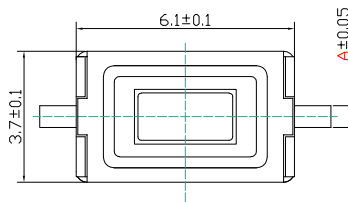

P. C. B MOUNTING PATTERN DIMENSION  
the following soldering are recommended for reflow soldering

项目	规格
额定电负荷:	DC12V 50mA
绝缘电阻:	≥100MΩ 100V DC/1min
耐压强度:	AC250V 50Hz/1min
电气寿命:	30,000 cycles Min
环境温度:	-40℃ ~ +85℃
接触电阻:	≤100mΩ Max
行程:	0.25±0.1mm
动作力:	160gf±30gf

6	盖板	SUS304	1	清洗
5	按钮	LCP/PPA	1	白/黑色
4	防尘膜	聚酰亚胺	0/1	黄色
3	弹片	SUS301	1	镀银
2	基座	LCP/PPA	1	白/黑色
1	卡件	磷铜	1	镀银
编号	部件名称	材料名称	数量	备注

未标注公差列表			
X.	±0.2	X.°	±1°
.X	±0.1	.X°	±0.5°
.XX	±0.05	.XX°	±0.3°
.XXX	±0.02	.XXX°	----
设计 DESIGN			
审核 CHECKED			
校核 STANDARD			
批准 APPROVE			

单位: UNIT	mm	
材质 MATERIAL		
重量 WT.		
图号 DWG NO.		
视图 VIEW	比例 SCALE	1 : 1
	版本 REV.	A0
日期	2020/03	

产品系列 Product series	轻触开关
产品名称 Product Title	3*6*2.5 直脚 拉伸盖一型
产品编码 Product number	
<b>东莞市溪榜电子有限公司</b> DONG GUAN XI BANG ELECTRONI CS CO., LTD.	
张数	第 页